

KANALGERÄT - MITTLERE PRESSUNG

TECHNISCHE DATEN

Y/FXSQ20-32A

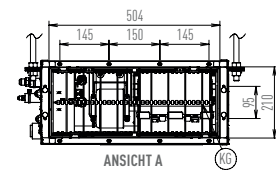
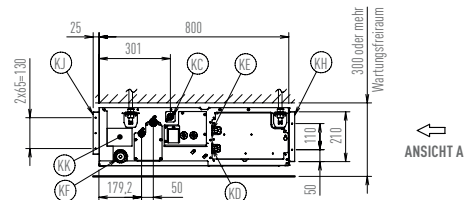
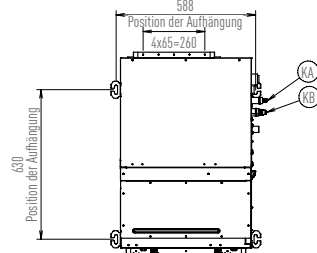
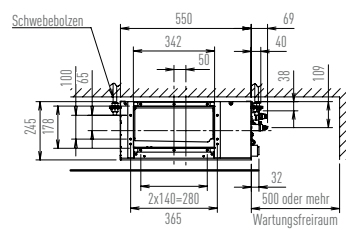
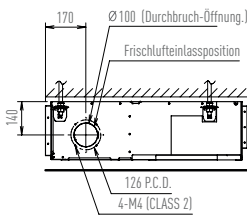

Y/FXSQ40-50A

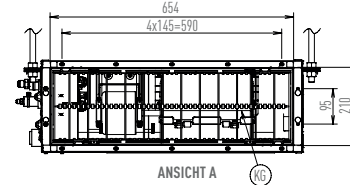
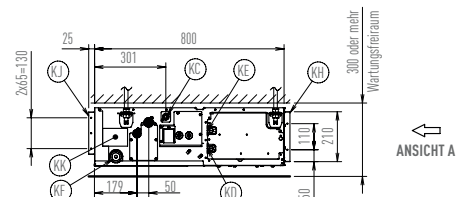
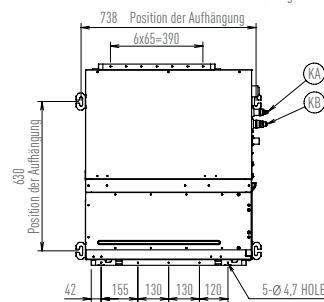
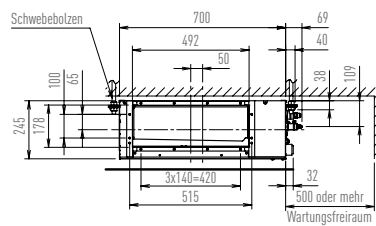
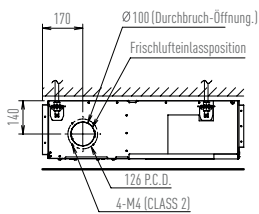

HINWEIS: Die kompletten technischen Skizzen und Legenden befinden sich im YANMAR Planungshandbuch.